



Electronic controller

IB-Tron 3100FAN-230V

for Air Handling Units (AHU)

THIS PRODUCT HAS THE  MARK

AND HAS BEEN MANUFACTURED IN ACCORDANCE WITH ISO 9001 STANDARD

The manufacturer promotes development policy. The right to make changes and improvements to products and instructions without prior notice is reserved!

The contents of this manual - texts and graphics are the property of the manufacturer or its subcontractors and are protected by law.

manual version: 2.13.0
firmware version: 07

Spis Treści

IB-Tron 3100FAN-230V

1	General information	4
2	Properties	4
3	Compatibility	4
4	Technical data	5
5	General thoughts	5
6	Scope of delivery	5
7	Principle of operation	5
8	Controller design	5
9	Dimensions	6
10	Control panel of the controller	6
11	LCD display	7
12	Mounting	8
13	Connection module	9
14	FAN digital input	10
15	Connection example	10
16	Connection - Zehnder Basic, AERIS 350 i 450 STANDARD, ITHO Daalderop Aure Vent D250	11
17	Connection - replacement of LEGRAND	11
18	Connection - single phase fan with autotransformer	11
19	Connection - low voltage cable	13
20	Installation notes	14
21	Turning the controller on	14

22 Configuration menu	14
23 Configuration of outputs	14
24 FAN input operation	16
25 Temporary ventilation level	16
26 Ventilation time	17
27 Calibration	17
28 Idle time	17
29 Backlight time	17
30 Backlight intensity	17
31 Temperature unit	18
32 Time format	18
33 Filter change reminder	18
34 Alarm states	18
35 Firmware version	18
36 Time and day of the week	19
37 Factory settings	19
38 Keypad lock	19
39 Operating schedule - AUTO mode	19
40 Manual mode	20
41 Semi-automatic mode	21
42 Errors	21
43 Operation instructions	21
44 Warranty terms and conditions	21

1 General information

The **IB-Tron 3100FAN-230V** controller is an independent microprocessor regulator equipped with a large liquid crystal LCD display, dedicated to operating air handling units (AHUs). The controller allows to control 3 ventilation levels, for which the signal of switching on is a short circuit of the corresponding lines to the common screw terminal.

The **IB-Tron 3100FAN-230V** controller allows to regulate the ventilation level in the building based on the programmed operating schedule or in manual mode.

The **IB-Tron 3100FAN-230V** controllers save energy costs by adjusting the ventilation level according to needs. They thus contribute to environmental protection and financial savings. Can be widely used in hotels, offices, supermarkets, factories, hospitals, residential homes and other buildings.

2 Properties

- ☞ Large backlit liquid crystal display showing current ventilation level, temperature, settings, day of the week and other information.
- ☞ 3 ventilation level to choose from.
- ☞ Possibility of defining the time after which the control panel switches to the filter change reminder mode (FILTER sign and acoustic signal).
- ☞ Aesthetic and modern design.
- ☞ Blue backlighting of the screen (backlighting is activated when any button is pressed and deactivated after some time of inactivity).
- ☞ Easy, intuitive operation and programming.
- ☞ Operating schedule of the process in a weekly cycle with the accuracy of 1 minute and the possibility of programming 4 time periods each day.
- ☞ Manual or automatic operating mode.
- ☞ Temperature displayed with 0,1°C resolution.
- ☞ Support for an additional digital input (three operating modes to choose from).
- ☞ Input for connecting a dirty filter signal from AHU. When this input is shorted to the neutral wire, the AHU will be turned off as a priority and an audible signal will sound.
- ☞ Power supply from 230V mains with battery backup of settings memory.

3 Compatibility

The controller can be installed in place of manual ventilation capacity switches, e.g:

- ☞ Legrand SISTENA LIFE switch for ventilation control 4 positions (0-1-2-3) 20A 250V cat. 775958.
- ☞ Zehnder ventilation switch SA 1-3V 4 positions (0-1-2-3) 20A 250V cat. 775958.

The controller is compatible with the following AHUs, among others:















- ☞ Zehnder ComfoAir 300, 350, 450, 550 Basic
- ☞ Tywent B3B, ZWC-B
- ☞ StorkAir
- ☞ NED AIR WTA HR 300, 400
- ☞ Aeris 350 Standard VV
- ☞ Mistral 300, 400, 250 ECONO
- ☞ Mistral Mini 250 (AC 230)
- ☞ Vasco D300EII, D400II, D400EPII, D500II, D500EII, DX4 E, DX5 E, DX6 E, X350, X425, X500, D275EP III
- ☞ Harmann Requira 20, 30, 40, 50
- ☞ ITHO ECO4, HRU-3 BVH-004, Daalderop Aure Vent D250
- ☞ Mitsubishi LGH Lossnay
- ☞ Dospel Luna
- ☞ Orcon HRC EcoMax, MaxComfort 300, 400, 500
- ☞ CLIMA Xtract ECO Plus Flat

Connection to sample AHUs later in this manual.



The controller can also be connected directly to the fans:

- ☞ single phase fans with „taps” controlling the fan speed. Such a fan can be recognized by the fact that it has PE, N wires and a few wires for supplying the control phase, e.g. L1, L2, L3. If the fan has only three wires, PE, N and L, it means that the fan is not factory set for speed change. In order to control such a fan, additional electrical components are required, e.g. inverter or autotransformer. An example of connection with such a fan using an autotransformer is given later in this manual.
- ☞ three-phase fans - the appropriate connection should be designed depending on the fan used.

4 Technical data

-  Power supply: 230 V AC
-  Max. contact load:
3A/240V \approx 700 W
-  Ventilation level signal: short circuit with COM1
-  Filter signal: short circuit with C2
-  Digital input: short circuit with C2
-  Number of ventilation levels: 3
-  Housing: ABS
-  Display: LCD (3,2")
-  Control: Electronic
-  Ingress Protection Code: IP30
-  Settings memory: 36 months
-  Dimensions
(height \times width \times depth):
 - \gg Control panel: 86 \times 86 \times 15 mm
 - \gg Connection module: 62 \times 45 \times 27 mm
-  Energy consumption: < 2 W
-  Storage temp.: $-5 \div 50^{\circ}\text{C}$
-  Display temp.: $-20 \div 140^{\circ}\text{C}$

5 General thoughts

-  The power supply should be turned off when installing the controller. It is recommended to entrust the installation of the controller to specialized personnel.
-  The controller is designed to work with devices for which the active signal of switching on ventilation levels is shorting the appropriate lines to the common screw terminal (COM1).
-  The common screw terminal (COM1) and the screw terminal of the individual ventilation le-

vels are isolated from the power supply - these are the so called potential-free outputs (dry contact).

6 Scope of delivery

-  1x Controller
-  1x User Manual

7 Principle of operation

When operating in automatic (operating schedule) mode, at the beginning of each time periods the controller switches on the ventilation level programmed for that time period. It is possible to program 4 time periods per day and to assign one of the available ventilation level to each of them.

In manual mode, the user sets the ventilation level of the air handling unit (AHU) by himself. The air handling unit (AHU) works in this mode all the time, until another ventilation level is set or the controller is switched off.

All ventilation level outputs are disconnected from the common screw terminal when the controller is off.

8 Controller design

The **IB-Tron 3100FAN-230V** controller consists of two parts: main panel with LCD display with keypad and connection module with screw terminal for connection of air handling unit, additional button, filter signal and power supply.

Both modules are connected with each other by a flat cable, several centimeters long.

9 Dimensions

Control panel:

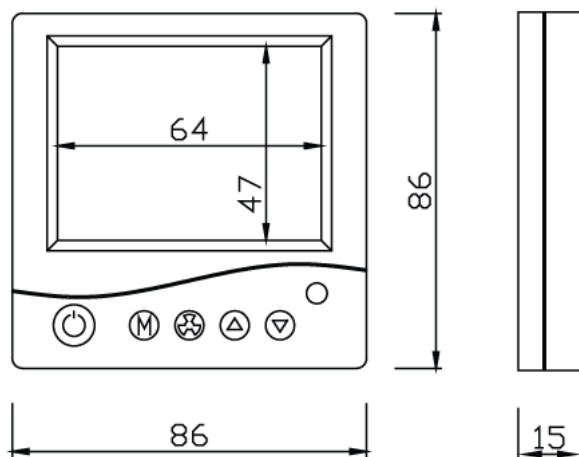



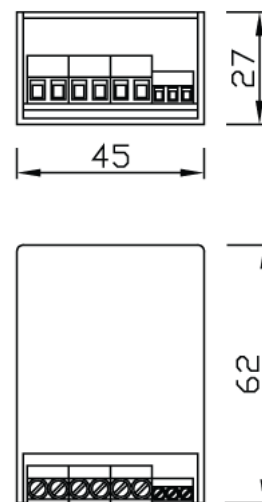

Connection module:

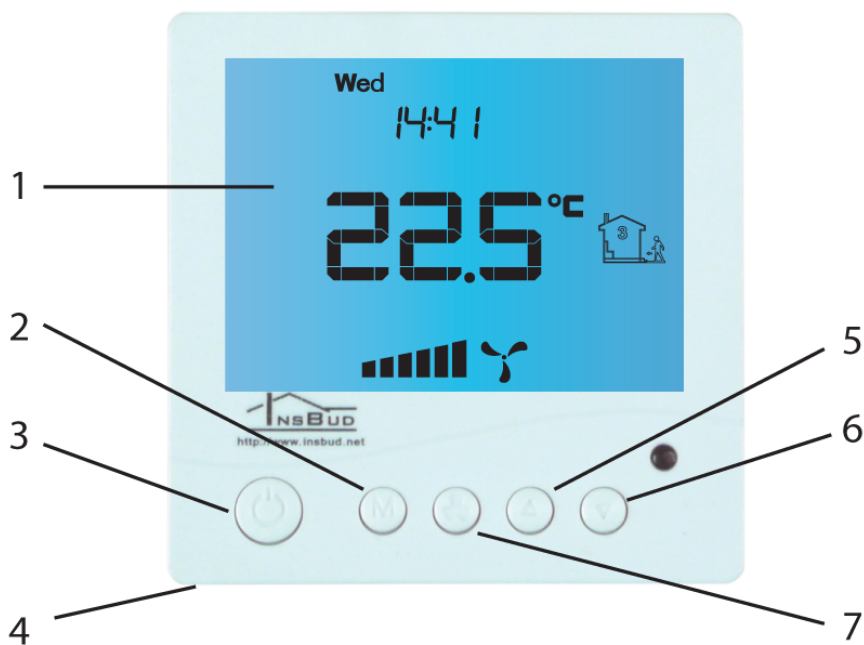

10 Control panel of the controller









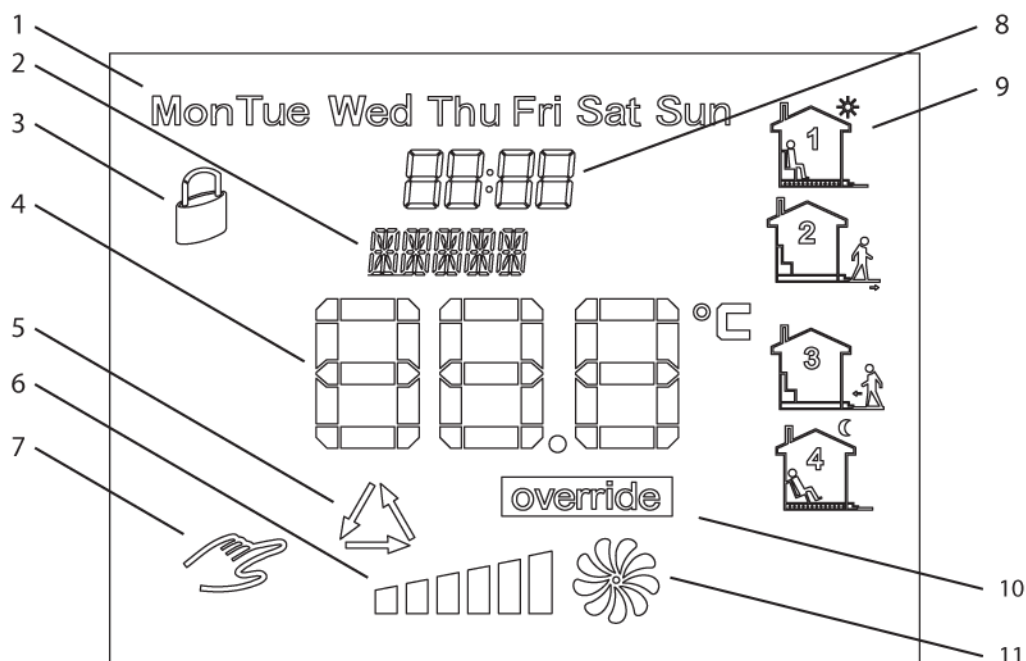



-  1 - display.
-  2 - M button.
-  3 - P button.
-  4 - temperature sensor.

-  5 - UP button.
-  6 - DOWN button.
-  7 - FAN/OK button.

11 LCD display



-  **1** - day of the week.
-  **2** - current ventilation level or information.
-  **3** - visible symbol means keypad lock.
-  **4** - temperature or setting value.
-  **5** - visible symbol means active ventilation mode.
-  **6** - graphic representation of the current ventilation level.

-  **7** - visible symbol means manual mode.
-  **8** - time.
-  **9** - time period.
-  **10** - visible symbol means active semi-automatic mode.
-  **11** - graphic representation of the current ventilation level. The animated fan rotates with different speed or is not visible.

12 Mounting

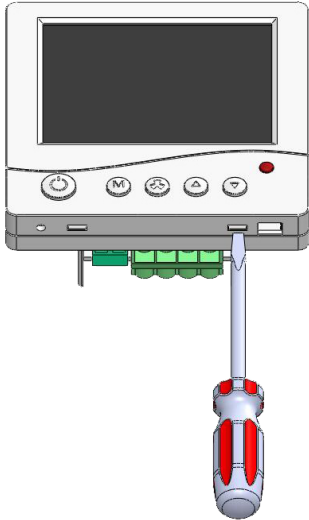

Separate the two parts of the main panel housing of the controller. To do this, insert a flat screwdriver into the two slots visible in the bottom part of the panel and lever the plastic catches.

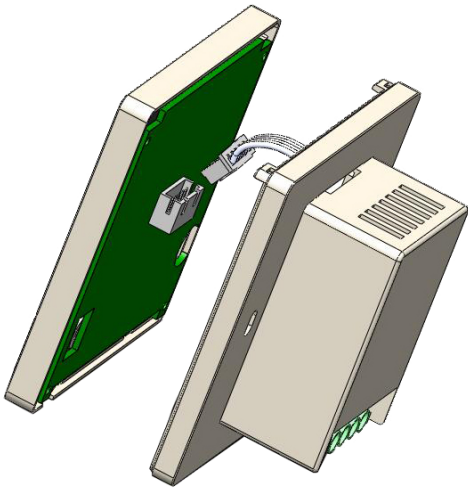

After levering the catches, carefully separate the two halves of the main panel. To avoid damaging the case, start from the lower part of the panel (from the catches side).

After separating both parts, disconnect the flat cable connecting the main panel with the connection module by pulling the plug from the socket in the front part of the panel.

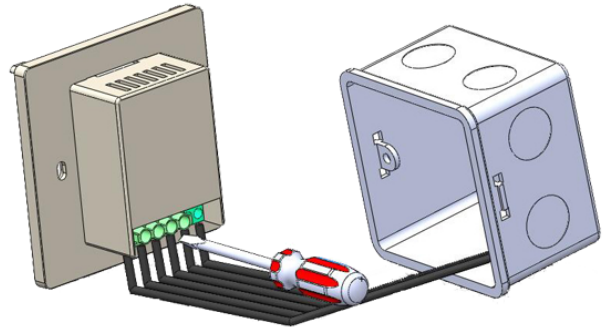

The controller wiring, led to the electrical installation box, should be connected to appropriate terminals of the controller, according to the manual.

 Make the connections with power off.

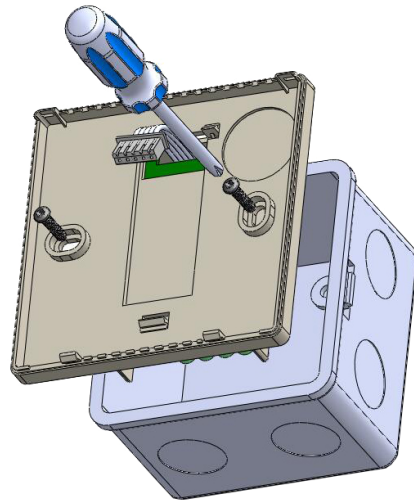

Carefully lay down excess wires in the cable installation box, avoiding stresses that could break wires from their terminals.

Place the connection module in the electrical installation box and screw the back part of the main panel casing with two screws.

13 Connection module

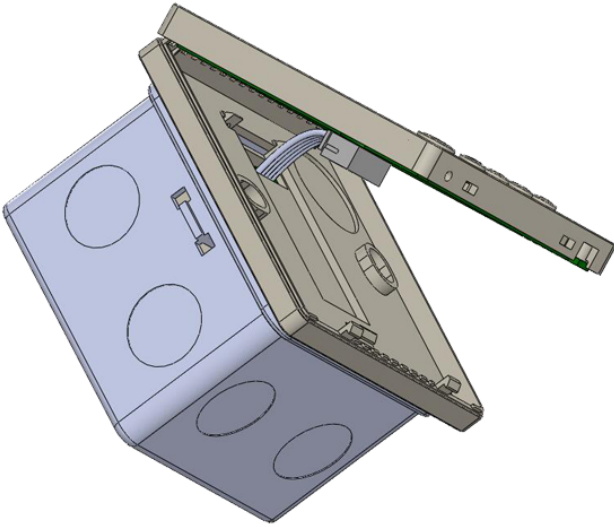







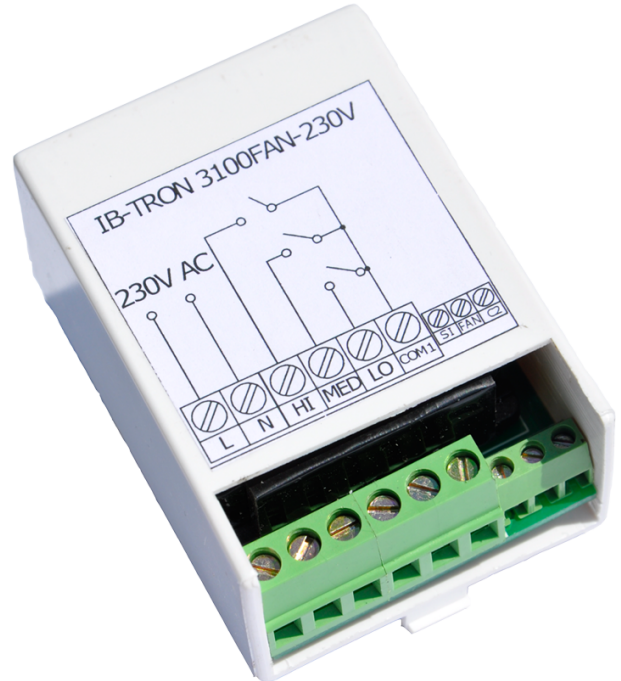



Connect the flat cable to the socket in the front part of the main panel.

Connect the two parts of the controller, starting with the catches at the top of the controller and ending with the catches at the bottom.

 For mounting, a rectangular mounting box of 80x80x50mm is recommended.



-  **L** - 230 V AC power supply phase.
-  **N** - neutral wire 230 V AC.
-  **HI** - high, third ventilation level output. This output is shorted to the common output when the controller wants to turn on the 3rd ventilation level of the panel.
-  **MED** - medium, second ventilation level. This output is shorted to the common output when the controller wants to turn on the 2nd ventilation level of the panel.
-  **LO** - low, first ventilation level. This output is shorted to the common output when the controller wants to turn on the 1st ventilation level of the panel.
-  **COM1** - common output of ventilation level..
-  **SI** - clogged filter signal input. When this input is shorted to **C2**, the alarm is activated.
-  **FAN** - digital input. Shorting this input to **C2** activates the input.
-  **C2** - common input to **SI** and **FAN**.

 The described situation of shorting **HI**, **MED**, **LO** to **COM1** refers to the situation when the setting parameter **CFG=4**. A detailed description of other relay states for other **CFG** value settings is described in the further part of the manual.





14 FAN digital input

The controller is equipped with an additional digital input **FAN** there can be connected e.g. a carbon monoxide, carbon dioxide, gas or air quality sensor (must have NO output). The active signal for this input is shorting the **FAN** output with **C2**. Typically a monostable button is connected to this input (so-called „bell” switch), is short-circuited when the

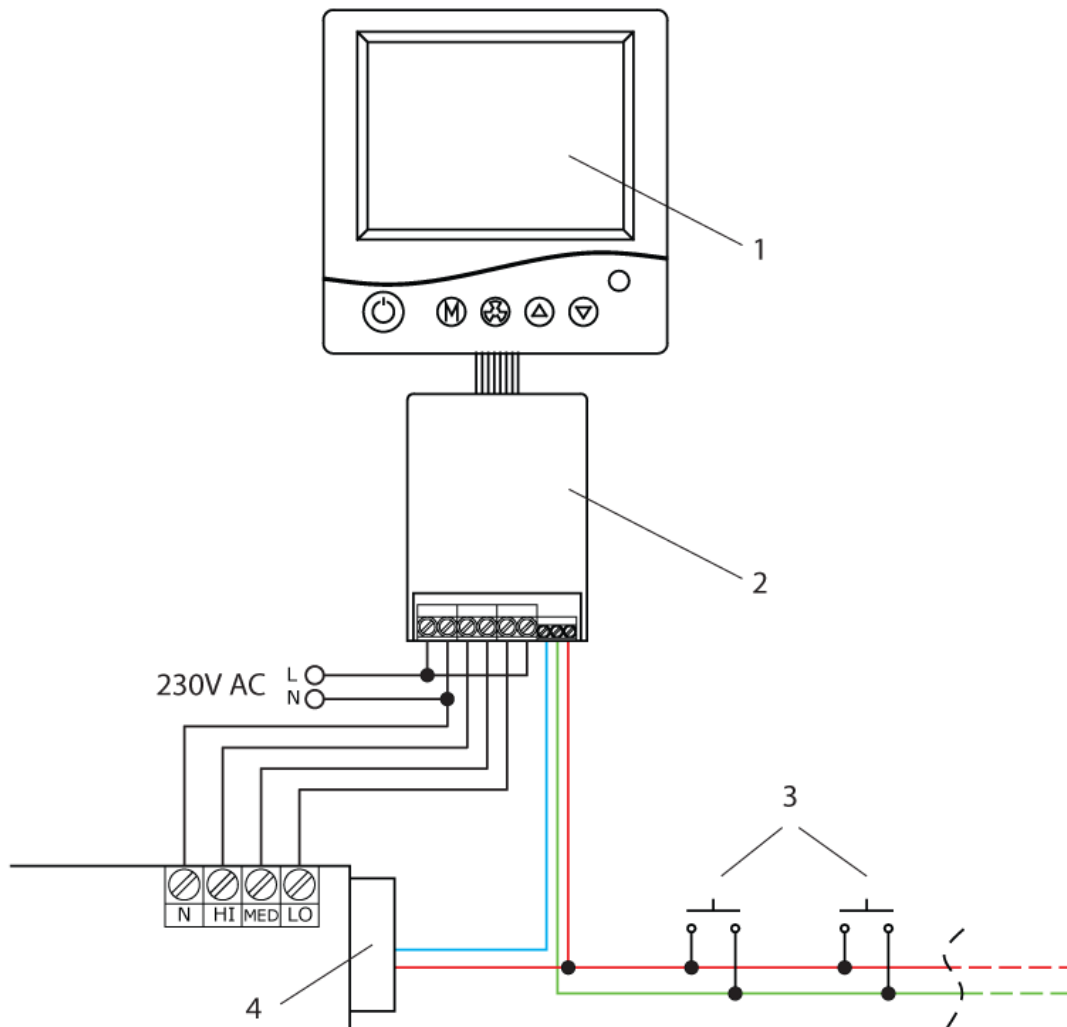
button is pressed and returns to the open position when the button is released (used, for example, on doorbells). Alternatively, one of the modes of operation of the **FAN** input provides for connection of a bistable switch (standard, „on/off” type, e.g. for lighting). Depending on the selected function (description later in this manual), the controller changes the ventilation level accordingly after shorting the digital input (pressing the button).

15 Connection example



-  1 - main panel
-  2 - connection module
-  3 - monostable buttons
-  4 - clogged filter sensor; differential pressure switch, etc.

16 Connection - Zehnder Basic, AERIS 350 i 450 STANDARD, ITHO Daalderop Aure Vent D250

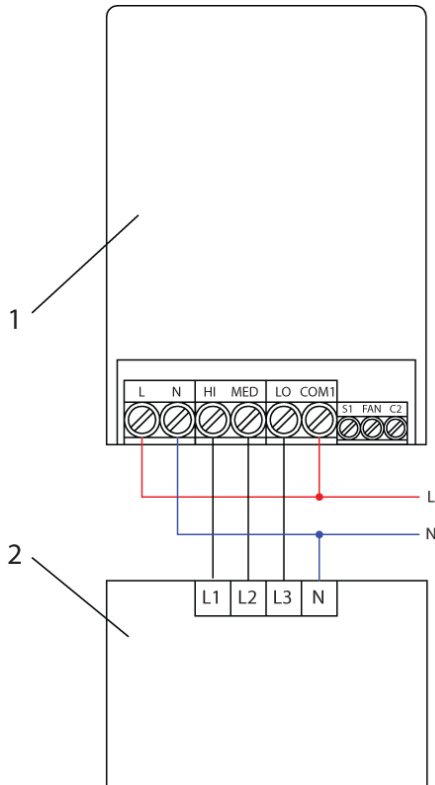

- ☞ 1 - the IB-Tron 3100FAN-230V controller
- ☞ 2 - AHU

In the configuration menu, set the parameter CFG=6.

17 Connection - replacement of LEGRAND

To replace the Legrand SISTENA LIFE switch for ventilation control 4 positions 0-1-2-3 (part number 775958) switch:

- ☞ 3 from Legrand switch - to HI screw terminal in controller
- ☞ 5 from Legrand switch - to MED screw terminal in controller
- ☞ 1 from Legrand switch - to LO screw terminal in controller

- ☞ 4 from Legrand switch - to L screw terminal in controller
- ☞ 8 from Legrand switch - to N screw terminal in controller
- ☞ 7 from Legrand switch (if connected) - to N screw terminal in controller

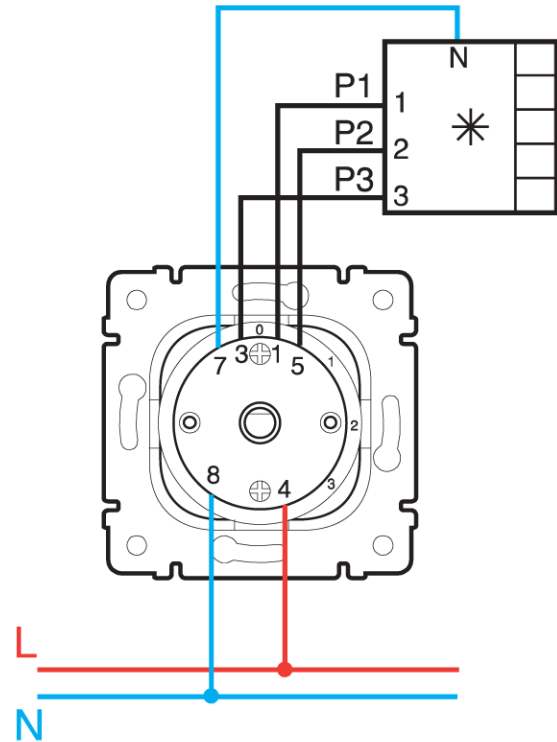

18 Connection - single phase fan with autotransformer

Below is an example of how to connect a IB-Tron 3100FAN-230V controller with a single-phase fan using an autotransformer. The example shows the connection of two fans connected on separate autotransformers with full isolation. In addition, there is a solution that turns off the autotransformer when the fans are about to be turned off, so that the autotransformer does not consume electricity during „idle state”.



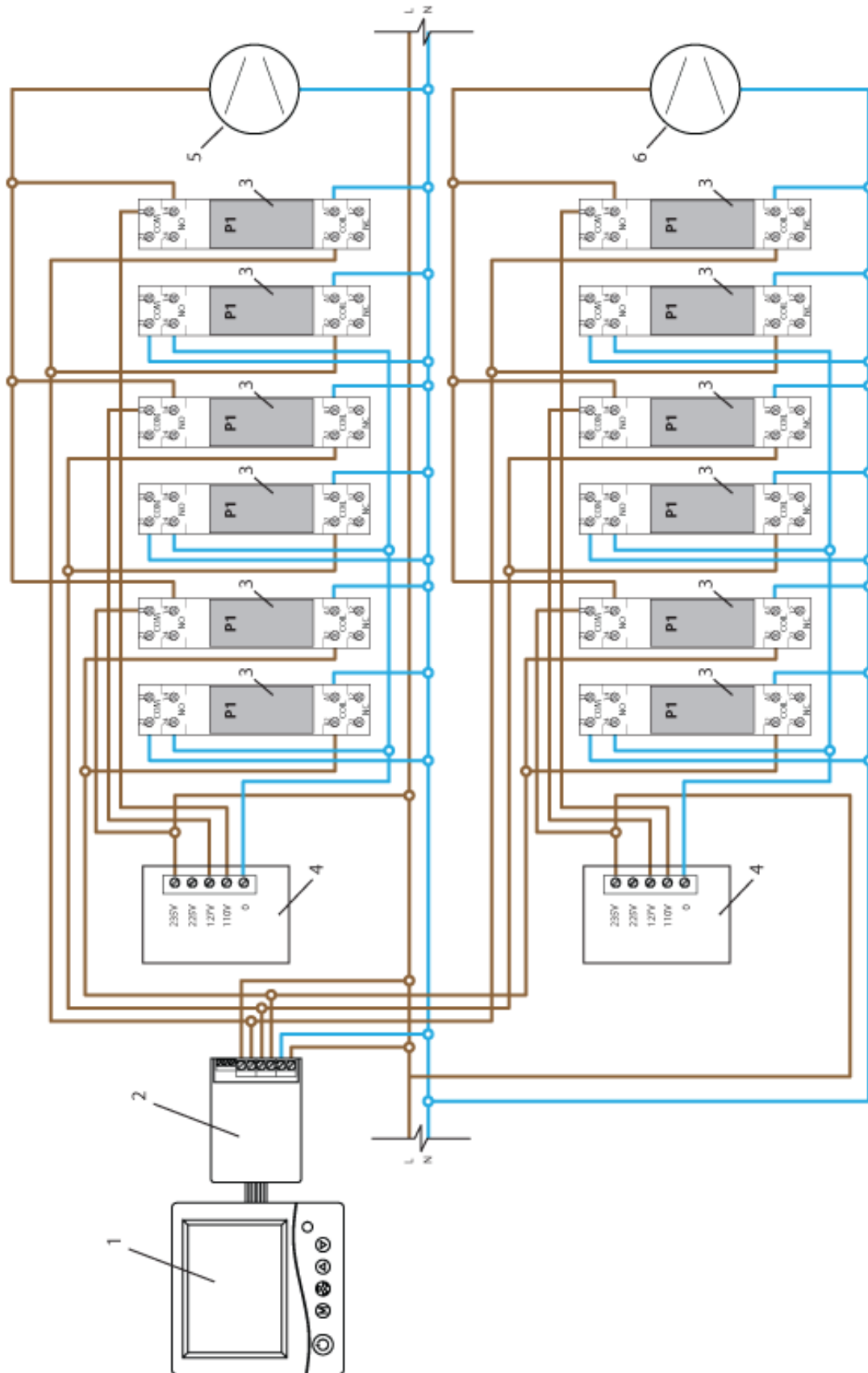

- ☞ 1 - main panel
- ☞ 2 - connection module
- ☞ 3 - 230V AC relay with a TH35 rail mounting base
- ☞ 4 - autotransformer
- ☞ 5 - supply fan
- ☞ 6 - exhaust fan



19 Connection - low voltage cable

If there is a low voltage cable between the AHU and the controller, e.g. if the control signal is a UTP cable and the control signal is a 230V phase, additional relays and a 12V power supply have to be used. The controller still requires a 230V power supply. If 230V

power supply is not available, use a low voltage controller. Below is an example of connection.

-  1 - main panel
-  2 - connection module
-  3 - low voltage cable, e.g. UTP cable
-  4 - 12V DC relay with TH35 rail mounting base
-  5 - AHU

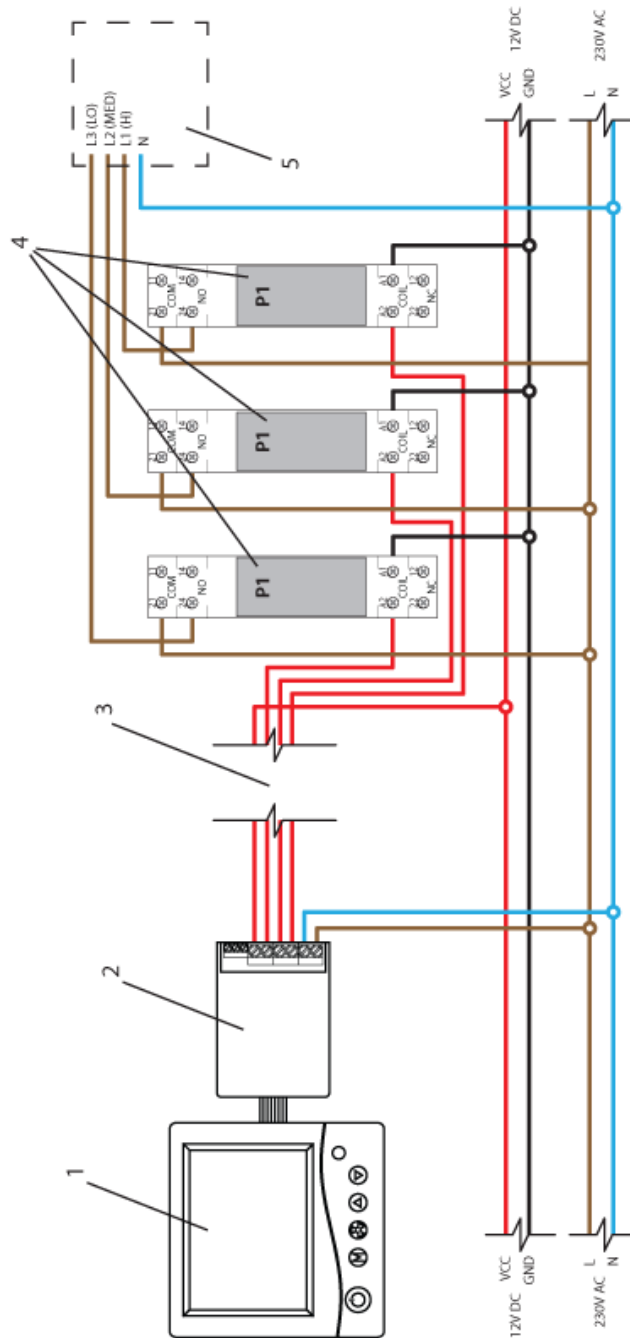

20 Installation notes

The main panel together with the connection module is usually installed in a generally accessible room, e.g. in the living room. The controller is connected to the AHU with a multi-wire cable.

In addition, one to several push buttons/switches can be connected in parallel to the connection module for remote ventilation level control.

Such buttons will be usually installed in rooms, which require temporary increase of ventilation level from time to time, e.g. in a toilet or a kitchen

Additional push buttons should be connected with a two-wire cable. Ideally, it should also be a twisted pair of wires, but this is not an absolute requirement. You can use a telephone cable or a two-wire cable of the „link” type.

The installation of additional buttons is optional. If buttons are not to be mounted, leave the button input terminal unconnected.

21 Turning the controller on

 To turn the controller on or off, press the **P** button.

When the controller is off, the display shows only the current temperature. All ventilation level outputs are deactivated (open circuit). When the controller is off, the clogged filter detection function is still active.

22 Configuration menu

The configuration menu is used to set the operating parameters of the controller. To enter the configuration menu:

 If the controller is on, turn it off by pressing the **P** button.

 With the controller off, press and hold the **M** button for about **3** seconds.

The controller is in the configuration mode. **Menu**, setting number, setting label, setting value and unit are displayed.

 To change the value of the setting shown, press the **DOWN** or **UP** button.



 To move to the next setting, press the **M** button. When the last setting is reached, pressing the **M** button again returns to the first setting.

The controller exits the configuration menu after the set time of inactivity has elapsed or after pressing either of the buttons: **P** or **FAN**. Pressing the **FAN** button or the inactivity time expires saves the changes and exits the configuration menu. Pressing the **P** button cancels the changes and exits the configuration menu.

23 Configuration of outputs

For different air handling units available on the market, particular ventilation levels may be switched on according to different standards. For example, for many air handling units lack of any signal from the controller means that the unit is switched on in the first ventilation level. For another type, to switch on the first ventilation level, it is necessary to give a signal to the appropriate input. Also, some AHUs allow the ventilation to be switched off by means of an attached controller, while others do not.

The **IB-Tron 3100FAN-230V** controller can control different types of air handling units. The user has a possibility to choose the proper signal standard for the air handling unit. This is done by the **CFG** parameter in the configuration menu.

6 types of AHUs have been defined, for which the **LO**, **MED** and **HI** outputs are switched on for particular ventilation levels as shown in the table:

CFG = 1

	Off	Ventilation level 1	Ventilation level 2	Ventilation level 3
Possible to set from the controller	No	Yes	Yes	Yes
Relay output states				
LO	N/A	On	Off	Off
MED		Off	On	Off
HI		Off	Off	On

The above settings means:

- » it is not possible to switch the AHU off from the controller (it is not possible to set „off” value in the operating schedule or in the manual mode). Other ventilation levels are available for setting.
- » if the controller wants to switch on the first ventilation level of the air handling unit then relays will be set as follows: LO = On (short circuit to COM1); MED = Off (open circuit with COM1); HI = Off (open circuit with COM1).
- » if the controller wants to switch on the second ventilation level of the air handling unit then relays will be set as follows: LO = Off (open circuit to COM1); MED = On (short circuit with COM1); HI = Off (open circuit with COM1).
- » if the controller wants to switch on the third ventilation level of the air handling unit then relays will be set as follows: LO = Off (open circuit to COM1); MED = Off (open circuit with COM1); HI = On (short circuit with COM1).

CFG = 2

	Off	Ventilation level 1	Ventilation level 2	Ventilation level 3
Possible to set from the controller	No	Yes	Yes	Yes
Relay output states				
LO	N/A	Off	Off	Off
MED		Off	On	Off
HI		Off	Off	On

CFG = 3

	Off	Ventilation level 1	Ventilation level 2	Ventilation level 3
Possible to set from the controller	Yes	Yes	Yes	Yes
Relay output states				
LO	On	Off	Off	Off
MED	Off	Off	On	Off
HI	Off	Off	Off	On

CFG = 4

	Off	Ventilation level 1	Ventilation level 2	Ventilation level 3
Possible to set from the controller	Yes	Yes	Yes	Yes
Relay output states				
LO	Off	On	Off	Off
MED	Off	Off	On	Off
HI	Off	Off	Off	On

CFG = 5

	Off	Ventilation level 1	Ventilation level 2	Ventilation level 3
Possible to set from the controller	Yes	Yes	Yes	Yes
Relay output states				
LO	Off	On	On	On
MED	Off	Off	On	Off
HI	Off	Off	Off	On

CFG = 6

	Off	Ventilation level 1	Ventilation level 2	Ventilation level 3
Possible to set from the controller	Yes	Yes	Yes	Yes
Relay output states				
LO	Off	Off	Off	On
MED	Off	Off	On	Off
HI	Off	On	On	On

To set the appropriate output signal standard:

 Enter the configuration menu. Press the **M** button until the setting number **01**, labeled **CFG**, appears on the display.

 Set the value. Exit the configuration menu or move to another setting.



24 FAN input operation

The user can choose one of the three modes of operating the additional digital input **FAN**. Mode 1 and 2 enables the use of a monostable button, mode 3 - a bistable switch.

1. **Ventilation.** After short pressing of the additional button, connected to the **FAN** input, temporary change of the ventilation level takes place (temporary ventilation). The user decides which ventilation level should be switched on at that moment, as well as the time how long this ventilation level is switched on. For example, if the button is placed in the kitchen, the user can temporarily set the highest ventilation level by pressing the button. Another example would be a button in the bathroom, which allows to temporarily stop ventilation while taking a bath to raise the temperature in the bathroom. After the ventilation time has elapsed, the controller will switch back to the mode the AHU was in before the button was pressed. To exit the ventilation mode before the expiry of the set ventilation time, press and hold the additional button for about **3** seconds. When the ventilation mode is active, the ventilation icon is shown on the control panel.

2. **Increasing ventilation level.** Each short press of the button increases the ventilation level. If the AHU is in the highest ventilation level, pressing the button switches on the lowest ventilation level (for AHU without the possibility to switch off) or switches off (for AHU with the

possibility to switch off). The sequence is repeated. If the controller operates in manual mode (**MANUAL**), pressing an additional button causes permanent change of ventilation level. If the

controller operates in automatic mode (**AUTO**), pressing the additional button causes switching to semi-automatic mode (**OVERRIDE**), i.e. ventilation level change until the end of the current time period. To return to automatic mode, press and hold the additional button for about **3** seconds.

3. **Ventilation level override.** This mode allows connecting a bistable switch to the digital input **FAN**. The switch can be placed e.g. near a kitchen hood. When this switch is activated (short-circuited), the programmed ventilation level is started and it lasts as long as the switch is activated. After deactivation of the switch (open-circuited), ventilation level returns to the mode, in which it was before the switch was activated. In this mode when digital input is short-circuited the ventilation icon is displayed on the screen.

To set FAN input operation:

 Enter the configuration menu. Press the **M** button until the setting number **02**, labeled **INMOD**, appears on the display.

 Set value 1 to set the ventilation function. Set value 2 to set increasing ventilation level function. Set value 3 to set the ventilation level override. Exit the configuration menu or move to another setting.



25 Temporary ventilation level

When an additional digital input FAN has been assigned a ventilate function (parameter **INMOD** = 1) or a ventilation level override function (parameter **INMOD** = 3), the user should define which ventilation level will be activated when the additional but-

ton is pressed in ventilate mode or when the switch is shorted in ventilation level override mode. To set the temporary ventilation level:

 Enter the configuration menu. Press the **M** button until the setting number **03**, labeled **b_SPd**, appears on the display.

 Set the ventilation level that will be started when the external button is pressed. Exit the configuration menu or move to another setting.



26 Ventilation time

When an additional digital input **FAN** has been assigned with ventilation function (parameter **INMOD** = 1), the user should define how long after pressing additional button ventilation should last. To set the ventilation time:

 Enter the configuration menu. Press the **M** button until the setting number **04**, labeled **bTIME**, appears on the display.

 Set the ventilation time in minutes (from 1 to 30). Exit the configuration menu or move to another setting.



27 Calibration

If the temperature indicated by the controller differs from the actual temperature, the temperature sensor should be calibrated. To set the calibration:

 Enter the configuration menu. Press the **M** button until the setting number **05**, labeled **CALIB**, appears on the display.

 Set the value by which the current temperature indication should be changed in order to obtain the correct indication. For example, if 20° C is displayed and the actual temperature is 18° C, set -2° C. Exit the configuration menu or move to another setting.





28 Idle time

Idle time is the time after which the controller exits parameter setting mode to default operating mode, calculated from the last time any of the buttons were

pressed. A larger value gives the user more time to enter settings.

To set the idle time:

 Enter the configuration menu. Press the **M** button until the setting number **06**, labeled **PTD**, appears on the display.

 Set the appropriate value. It can be selected from the range of 5 ÷ 30 s, with a step of 5s.

 Exit the configuration menu or move to another setting.

29 Backlight time

Backlight time is the time after which the LCD backlight turns off, calculated from the last time any of the buttons were pressed. To set the backlight time:

 Enter the configuration menu. Press the **M** button until the setting number **07**, labeled **LIGHT**, appears on the display.

 Set the appropriate value. It can be selected from the range of 10 ÷ 60 s, with a step of 10s.

 It can also be set to **OFF** - backlight always off or **On** - backlight always on. Exit the configuration menu or move to another setting.

30 Backlight intensity

The **IB-Tron 3100FAN-230V** controller is programmed to automatically turn off the screen backlight when the backlight time expires. By default, the backlight is then turned off completely. However user can set the controller not to turn off the backlight completely, but only to decrease its intensity. User can also set the backlight intensity when the controller is active.

To set the intensity of the backlight when the controller is active:



 Enter the configuration menu. Press the **M** button until the setting number **08**, labeled **LT_oN**, appears on the display.

 Set the intensity of the backlight (in percent) that will be maintained when the controller is active. Exit the configuration menu or move to another setting.



To set the intensity of the backlight when the controller is inactive:

 Enter the configuration menu. Press the **M** button until the setting number **09**, labeled **LT_oFF**, appears on the display.



 Set the backlight intensity (in percent) that will be maintained after the backlight timeout (instead of turning it off completely). Exit the configuration menu or move to another setting.

31 Temperature unit

The user can choose whether to display the temperature in degrees Celsius °C or Fahrenheit °F.

To set the temperature unit:



 Enter the configuration menu. Press the **M** button until the setting number **10**, labeled **UNIT**, appears on the display.

 Set the temperature unit. Exit the configuration menu or move to another setting.

32 Time format

The user can choose whether to display the time in 12 or 24 hour format. To set the time format:



 Enter the configuration menu. Press the **M** button until the setting number **11**, labeled **CLOCK**, appears on the display.

 Set 12 or 24 hour format. Exit the configuration menu or move to another setting.

33 Filter change reminder

The user can set a reminder to change the filter. User need to specify the time after which the control panel enters the reminder mode. To set the filter change reminder:

 Enter the configuration menu. Press the **M** button until the setting number **12**, labeled **FILTR**, appears on the display.

 Set the number of days after which the filter change reminder is activated or set „OFF” to disable the reminder. Exit the configuration menu or move to another setting.



 When the time limit expires, repeat the step of setting the number of days, otherwise the alarm is still active.

34 Alarm states

The controller can report alarms (e.g. filter change) both when it is on and when it is off. To set whether the alarm information is to be displayed also when the controller is switched off:

 Enter the configuration menu. Press the **M** button until the setting number **13**, labeled **ALoFF**, appears on the display.

Set the appropriate setting:

 **YES** - alarms are always reported.
 **NO** - no alarms are reported when the controller is in the off mode.

Exit the configuration menu or move to another setting.

35 Firmware version

To check the firmware version:

 Enter the configuration menu. Press the **M** button until the setting number **14**, labeled **VER**, appears on the display.









The manufacturer promotes a policy of development and therefore reserves the right to make changes to the controllers and manuals without prior notice.

The manufacturer is open to all kinds of suggestions that will improve our controllers. If you have an idea for adding a new feature or need an unusual solution, please contact us.

This manual is valid for **IB-Tron 3100FAN-230V** controller with firmware version **07**.





36 Time and day of the week

To set the current time and day of the week:

-  Turn on the controller.
-  Press and hold the **FAN** button for about **3** seconds. The displayed time starts flashing.
-  Set the current time.
- 
-  Press the **FAN** button again. The day of the week will start flashing.
-  Set the day of the week:
 - » Mon - Monday.
 - » Tue - Tuesday.
 - » Wed - Wednesday.
 - » Thu - Thursday.
 - » Fri - Friday.
 - » Sat - Saturday.
 - » Sun - Sunday.
- 
-  Confirm the settings.

37 Factory settings

To reset the controller and return to the factory settings:



-  Turn off the controller.
-  Press and hold for about 3 seconds both buttons: **M** and **FAN** simultaneously.
- 
-  The display will show **RESET** for about 5 seconds.

38 Keypad lock

To protect the controller from unwanted changes to settings, user can lock the keypad.

When the keypad lock is active, the display shows a padlock symbol and the keypad does not respond to the pressed keys.

To enable/disable the keypad lock:





-  Press and hold for about 3 seconds both keys: **DOWN** and **UP** simultaneously.
- 

39 Operating schedule - AUTO mode



In automatic mode, user can set an operating schedule. It means that the programmed ventilation level of the AHU is automatically set at certain time.

Thanks to the operating schedule it is possible to set ventilation level lower in the periods when, for example, the building is not used or during the night, and higher when the building is used.

Four time periods can be programmed for each day of the week, which are symbolically represented on the display:

-  Time period no. 1.
e.g. 7:00 - wake-up call
-  Time period no. 2.
e.g. 9:00 - leaving home
-  Time period no. 3.
e.g. 15:00 - returning home
-  Time period no. 4.
e.g. 21:00 - sleep

To set the operating schedule:

-  Turn on the controller. Make sure that the controller is set to automatic mode (time periods and **AUTO** symbols are visible on the display).
-  If the hand symbol (manual mode) appears on the display instead of the time periods symbol, press the **M** button. Pressing this button when the controller is turned on switches between manual and automatic mode.

 Press and hold the **P** button for about 3 seconds. The display will show **PROG** and the current day of the week will start flashing.

 Using the **DOWN** and **UP** buttons, set the day of the week. Pressing and holding the **UP** button will select the entire week. Pressing and holding the **UP** button again will select the days of the week from Monday to Friday. Pressing and holding the **UP** button again to select only Saturday and Sunday.

 Confirm the selection with the **P** button.

 The following steps describe the programming of one time period. Repeat these steps for all four time periods. The symbol of the programmed time period is displayed on the right side of the display.

 The time at which the time period should start flashes on the display. Set the appropriate time.

 Confirm the selection with the **P** button.

 The ventilation level symbol for the time period flashes on the display. Set the appropriate ventilation level, where:

 **OFF** - AHU is turned off. Available for some types of air handling units.
LO - low, first ventilation level.
MED - medium, second ventilation level.
HI - high, third ventilation level.

 Confirm the selection with the **P** button.

 Repeat the above steps for all the time periods.

 After programming all four time periods, the controller returns to standard display mode.

 The fourth time period lasts until the beginning of the first time period of the following day (e.g. from 21:00 on Monday to 7:00 on Tuesday).

 When the controller is in the manual mode, the display shows the hand symbol and no time period symbol.





 The controller remains in manual mode until the user changes it to automatic mode.

To change the mode to manual/automatic, do the following:

 When the controller is on, press the **M** button.

To set ventilation level in manual mode, do the following:

 Press the **DOWN** or **UP** button. The display shows the current ventilation level. Set the new ventilation level setting.

 Confirm the selection with the **FAN** button.

Additionally, if an external pushbutton(s) is connected to the **FAN** input terminal and the **INMOD** parameter is set to 2, each time the external pushbutton is pressed, the ventilation level increases.

If the air handling unit is in the highest ventilation level, pressing the external push button causes the first ventilation level to be switched on (for AHU without the possibility to switch off) or switch off (for AHU with the possibility to switch off). The sequence is repeated in a circle.

The individual ventilation levels correspond to the following graphical representation in the bar chart at the bottom of the display:

- » AHU off - no bars;
- » first ventilation level - two bars;
- » second ventilation level - four bars;
- » third ventilation level - six bars;

Furthermore, the fan symbol in the lower part of the display is animated faster or slower.

40 Manual mode



In manual mode, the controller constantly maintains the set ventilation level (without operating schedule).

41 Semi-automatic mode

In semi-automatic mode, the ventilation level for the current time period is adjusted manually. This means that user set a different ventilation level for the current time period according to operating schedule. When the current time period is finished, the controller returns to automatic mode and continues to operate according to the schedule.

 You can only switch to semi-automatic mode from automatic mode.

To make a manual ventilation level correction for the current time period, do the following:

-  When the controller is in automatic mode, press the **DOWN** or **UP** button. The display will show the current ventilation level setting.
-  Set a new setting.
-  Confirm the selection with the **FAN** button.

 When the controller is in semi-automatic mode, the display shows „**override**”. At the same time, the symbol of the current time period disappears.

To cancel the ventilation level manual correction before the current time period ends and return to the operating schedule:

-  Press the **FAN** button.

Additionally, if an external button (or buttons) is connected to the **FAN** digital input and the **IN-MOD** parameter is set to 2 and the controller is in automatic mode, each time the external button is pressed, the ventilation level increases and the controller enters semi-automatic mode.

The semi-automatic mode can then be exited by pressing the **FAN** button on the keypad or by pressing and holding the external button for about 3 seconds.

42 Errors

When the air handling unit indicates a clogged filter, the word **FILTR** appears on the controller display

and a beep sounds (also when the controller is turned off). Po przeczyszczeniu lub wymianie filtra sygnalizacja powinna ustąpić. After cleaning or replacing the filter the indication should stop.







43 Operation instructions

 If it is suspected that the controller is not functioning properly, it is first recommended to reset the device to the factory settings. The description of how to perform the reset to factory settings can be found in **factory settings** section of this manual.



 The next step in diagnosing the cause of the malfunction is to check the correctness of attaching the cables to the connection module of the controller.

 It is also necessary to check continuity of the wires connecting the connection module with the air handling unit, as well as the **FAN** digital input wires, if any are connected.



44 Warranty terms and conditions

-  Warranty is for a period of 24 months from the date of purchase of goods.
-  Defects revealed during the warranty period shall be repaired within 21 working days, counting from the date of taking the equipment to the service.
-  If it is necessary to import goods or parts from abroad, repair time is extended by the time necessary to import them.
-  The customer delivers and collects the goods to the service at his own expense. Goods sent at the expense of the service will not be accepted.
-  Service is not obligated to provide the purchaser with replacement goods for the duration of the repair.
-  Repair under warranty will be made upon presentation of a clearly described defect, customer contact information and sales document.
-  Warranty covers only defects caused by reasons inherent in the product sold. The warranty does not cover damages caused by external factors such as: mechanical damage, contamination, flooding, atmospheric phenomena,

improper installation or operation, as well as operation inconsistent with the intended use and operating instructions. The warranty does not apply if the customer makes unauthorized repairs, changes to the firmware or formatting the device.

-  Due to natural wear and tear of consumables, some of them are not covered by the warranty (e.g. cables, batteries, chargers, micro-contacts, buttons, etc.).
-  In case of an unjustified claim for warranty re-

pair, the costs of sending the equipment to and from the service shall be borne by the Customer.

-  The service centre has the right to refuse warranty repair in case of: finding inconsistencies between the data in the documents and on the equipment, making repairs on their own, changes in equipment design.
-  Refusal to perform warranty repair is equivalent to loss of warranty.